



Type(s)  
Project  
Date  
Notes

GENERAL INFORMATION

ETC, the market leader in automated luminaire innovation, brings you the next generation hallmark of white light framing fixtures. High End Systems Halcyon Gold, the smallest product in the Halcyon Framing family of fixtures, is a compact luminaire with over 31,000 lumens of output in a 62 lb frame. Easily outperforming fixtures of the past in size and weight, Halcyon Gold has an extreme feature set with everything a user needs to light shows of all shapes and sizes.

Applications

- Houses of worship
- Small to medium-sized performance venues
- Cruise ships and themed entertainment
- Production rental companies
- Trade show and ballroom AV
- Studio and film

Product Features

- Bright white LED engine
- 430 W Ultra-Bright engine
- Fixture output exceeding 31,000 lumens
- High quality 13-lens optic system
- Extremely versatile 6°–57° field angle zoom
- Optimized CMY and CTO color mixing for even hue control
- Seven position plus open color wheel
- Full-curtain framing system for total control of beam shaping
- 16-blade iris for extremely tight beam effects
- Beautifully linear Trifusion frost system
- Seven position plus open Rotating Gobo Wheel
- Eight position plus open Fixed Gobo Wheel
- Dual prisms for compound beam and projection effects
- Rotating Animation Wheel with linear positioning and angular control
- Patented Whisper Home technology for quiet pan and tilt calibration/homing at boot with minimal movement

ORDERING INFORMATION

Model	Description
HAL-G-UB-MI	Halcyon Gold, Black, Ultra-Bright in Molded Insert, Boxed
HAL-G-HF-MI	Halcyon Gold, Black, High Fidelity in Molded Insert, Boxed
RC-HAL-G	Road Case, Holds up to Two (2) Halcyon Gold Fixtures in Molded Insert

**Color Options:** Fixtures ship standard in black. White available by request.  
**Included Accessories:** Fixture includes two (2) Omega brackets, one (1) fixture power cord, bare ends to powerCON® TRUE1® TOP input, and a safety cable.

Accessories

Model	Description
HAL-G-SNOOT	Top Hat, Snoot for Halcyon Gold
2500B7029-A	Fixture Power Cord Upgrade, 6 ft TRUE1 TOP to Parallel Blade U-Ground (Edison)
2560B7005	Fixture Power Cord Upgrade, Stage Pin to powerCON TRUE1 TOP, 20 A
2560B7006	Fixture Power Cord Upgrade, L6-20 to powerCON TRUE1 TOP, 20 A
2560B7007	Fixture Power Cord Upgrade, L5-20 to powerCON TRUE1 TOP, 20 A
67040007	MegaClaw™
55040014	Cheeseborough 2" Alloy 1/2 Coupler Truss Clamp
67040010	Mini-Claw™



PRODUCT SPECIFICATIONS

Source

Engine	Ultra-Bright	High Fidelity
LED Details	430 W	430 W
Field Lumens	See photometrics on page 4	
Max Integrating Sphere Lumens	31,000 lumens	19,000 lumens
LPW	72	44
LED Life	50,000 hours	50,000 hours
Native CCT	6500 K	5800 K

Color

Color Mixing	Cyan, magenta, yellow, CTO
Color Temperature	Variable down to 3000 K
Color Wheel	Seven (7) dichroic colors plus open

Optical

Beam Angle Range	6°–57°
Gate Size	22 mm
Aperture Size	124 mm
Pattern Projection	- Rotating and indexable wheel with seven (7) interchangeable patterns plus open - Fixed wheel with eight (8) interchangeable patterns plus open
Animation	- Bi-directional rotating animation wheel with linear insertion, and variable angle - LED Animation
Prism	Five-facet star and four-facet linear rotating prism with simultaneous insertion
Diffusion	Light, Medium, and Heavy frost seamlessly controlled with Trifusion control.
Iris	16-blade iris
Framing	Four-plane, full-curtain framing system with 180° module rotation
Flicker Control/Hz Range	2.4 kHz and 16 kHz

Control

Input Method	DMX (5-pin) or Ethernet
Protocols	DMX via RS-485 Art-Net or sACN via Ethernet
Ethernet Pass-Thru	Passive Ethernet in and thru with and without power
Data Conversion	Patented data conversion system for Ethernet to DMX
Modes (Footprint)	Standard (57 channels)
RDM Functions	Yes
UI Type	Full-color graphical UI with touch screen and 5-button navigational control NFC Configuration
Local Control	Yes
Dimming Performance	16-bit, DMX controlled

**Notes:** All LED sources experience some lessening of light output and some color shift over time. LED output will vary with thermal conditions. Thermal conditions can be affected by ambient temperatures and orientation.

Electrical

Voltage Range	100–240 V 50–60 Hz
Input Method	powerCON TRUE1 TOP
Wattage (Standard/Max/Standby)	668 W / 684 W / 26 W
Current (Max)	6.9 A @ 100 V
Inrush (First Half Cycle)	120 V: 47 A 230 V: 87 A
Fixtures per Circuit	2 fixtures (R20 module or similar) Note: TRUE1 TOP connector rated for 20 A (120 V / 60 Hz) and 16 A (240 V / 50 Hz)

Thermal

Ambient Operating Temp	-10°–40°C (14°–104°F)
Fan Mode	Standard, Studio, and Linear Continuous control channel

Physical

Pan and Tilt Range	542° pan, 259° tilt
Max Pan/Tilt Speed	360° in 2.52 s / 180° in 1.65 s
Encoders	Whisper Home, absolute encoders
Materials	Steel and aluminum frame with molded plastic covers
Color Options	Black, white by request
Mounting Options	Any orientation
IP Rating	IP20
Weight	28.1 kg (62 lb)
Included Accessories	powerCON TRUE1 TOP to bare end fixture tail Two (2) clamp brackets Safety cable

Warranty

Fixture Warranty	Five (5) years for light engine Two (2) years for complete fixture
Warranty Details	<a href="http://etcconnect.com/Support/Warranty.aspx">etcconnect.com/Support/Warranty.aspx</a>

Regulatory & Compliance

Approved regulatory standards	cETLus Listed Listed to UL 1573 Certified to CSA STD. C22.2 No: 166 CE Compliant UKCA Compliant
Complies to the ROHS directive	Yes

Safety

Safety	Minimum distance to illuminated surface = 3.0 m (9.8 ft) Minimum distance from fixture head to combustible materials = 0.1 m (4.0 in)
--------	--

FEATURE DETAILS

Rotating Gobo Details

Outside Diameter	25.5 mm (1.00 in)
Image Diameter	18 mm (0.7 in)
Materials	0.5 mm aluminum 1.1 mm glass Borofloat®

Rotating Gobo Wheel

Fixed Gobo Wheel

1 - Wiggle Lines

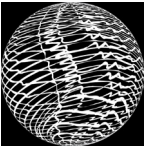

1 - Texture Drops

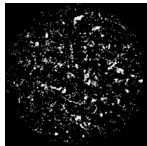

2 - Mycelium



2 - Lovely Bubbly

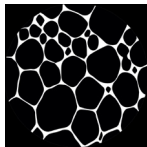

3 - Bob's Brush

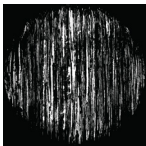

3 - Art Ducko

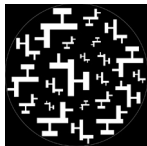

4 - The Claw



4 - Window Matrix

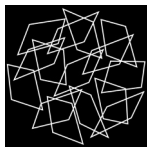

5 - Cut Cone

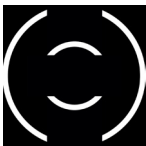

5 - Swirly Gig

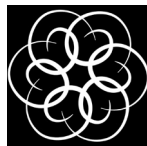

6 - Split-S



6 - Fenced In

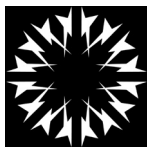

7 - Ice

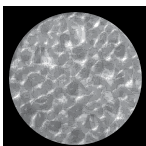

7 - The Only Way Is Up

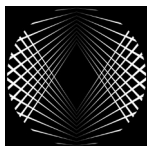

8 - Repeater

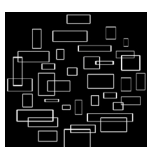

Color Wheel Details

Shape	Interchangeable wedge
Materials	1.1 mm glass Borofloat

1 - Red



2 - Blue



3 - TM-30

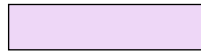

4 - Purple



5 - Orange



6 - Dark Blue



7 - CTB

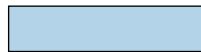

Prism Details

Movement	Two prism flags with individual or simultaneous insertion
Materials	Molded optical glass

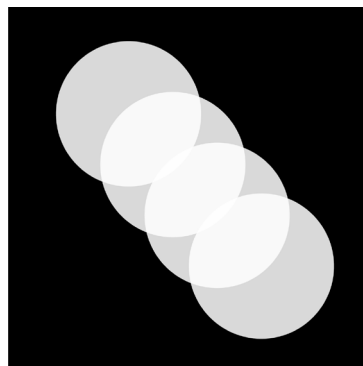
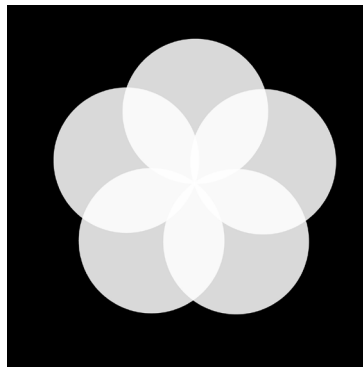

Animation Wheel Details

Movement	Bi-directional continuous rotation
Materials	0.8 mm aluminum

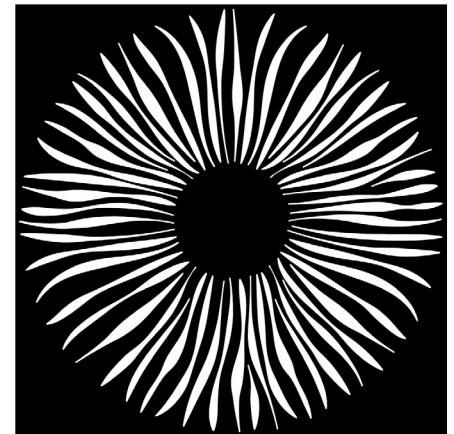

PHOTOMETRIC DATA

Halcyon Gold - Ultra-Bright

	Degree	Candela	Field Lumens	Power Usage	Lumens Per Watt
Narrow	6°	1,638,000	10,648	430 W	25
Medium	26°	182,200	22,677	430 W	53
Wide	57°	37,700	24,188	430 W	56

Narrow - 6°

Throw Distance	10 ft 3.0 m	20 ft 6.1 m	30 ft 9.1 m	50 ft 15.2 m	200 ft 61 m
Field Diameter	0.7 ft 0.21 m	1.3 ft 0.41 m	2.0 ft 0.61 m	3.3 ft 1.02 m	13.3 ft 4.05 m
Illuminance (fc)	16,380	4,095	1,820	656	41
Illuminance (lux)	176,246	44,062	19,583	7,050	441

Medium - 26°

Throw Distance	10 ft 3.0 m	20 ft 6.1 m	30 ft 9.1 m	50 ft 15.2 m	200 ft 61 m
Field Diameter	4.6 ft 1.41 m	9.2 ft 2.82 m	13.9 ft 4.23 m	23.1 ft 7.04 m	92.3 ft 28.15 m
Illuminance (fc)	1,822	456	203	73	5
Illuminance (lux)	19,601	4,900	2,178	784	49

Wide - 57°

Throw Distance	10 ft 3.0 m	20 ft 6.1 m	30 ft 9.1 m	50 ft 15.2 m	200 ft 61 m
Field Diameter	10.9 ft 3.31 m	21.7 ft 6.62 m	32.6 ft 9.93 m	54.3 ft 16.55 m	217.2 ft 66.20 m
Illuminance (fc)	377	95	42	16	1
Illuminance (lux)	4,054	1,013	450	162	10

To determine center beam illumination in footcandles at any throw distance, divide candela by the throw distance squared.

Metric conversions: For meters, multiply feet by 0.3048.  
For lux, multiply footcandles by 10.76.

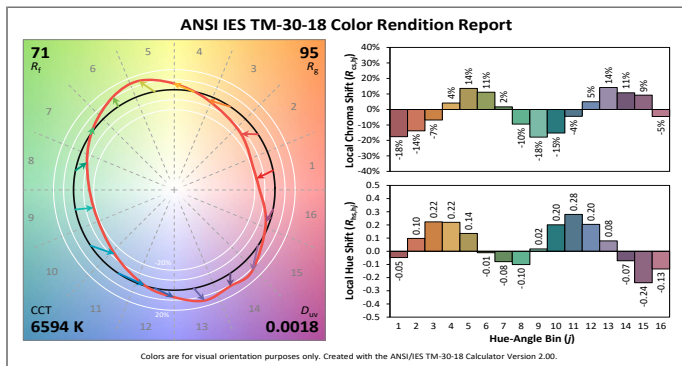

Additional Color Metrics	
CRI $R_a$ ( $R_g$ )	71 (-30)
TLCI	47

Halcyon Gold - High Fidelity

	Degree	Candela	Field Lumens	Power Usage	Lumens Per Watt
Narrow	6°	945,300	7,527	430 W	18
Medium	26°	97,300	14,502	430 W	34
Wide	57°	21,000	15,858	430 W	37

Narrow - 6°

Throw Distance	10 ft 3.0 m	20 ft 6.1 m	30 ft 9.1 m	50 ft 15.2 m	200 ft 61 m
Field Diameter	0.7 ft 0.21 m	1.3 ft 0.41 m	2.0 ft 0.61 m	3.3 ft 1.02 m	13.3 ft 4.05 m
Illuminance (fc)	9,453	2,364	1,051	379	24
Illuminance (lux)	101,706	25,427	11,301	4,068	254

Medium - 26°

Throw Distance	10 ft 3.0 m	20 ft 6.1 m	30 ft 9.1 m	50 ft 15.2 m	200 ft 61 m
Field Diameter	4.6 ft 1.41 m	9.2 ft 2.82 m	13.9 ft 4.23 m	23.1 ft 7.04 m	92.3 ft 28.15 m
Illuminance (fc)	973	244	109	39	3
Illuminance (lux)	10,460	2,615	1,162	418	26

Wide - 57°

Throw Distance	10 ft 3.0 m	20 ft 6.1 m	30 ft 9.1 m	50 ft 15.2 m	200 ft 61 m
Field Diameter	10.9 ft 3.31 m	21.7 ft 6.62 m	32.6 ft 9.93 m	54.3 ft 16.55 m	217.2 ft 66.20 m
Illuminance (fc)	210	53	24	9	1
Illuminance (lux)	2,259	565	251	90	6

To determine center beam illumination in footcandles at any throw distance, divide candela by the throw distance squared.

Metric conversions: For meters, multiply feet by 0.3048.  
For lux, multiply footcandles by 10.76.

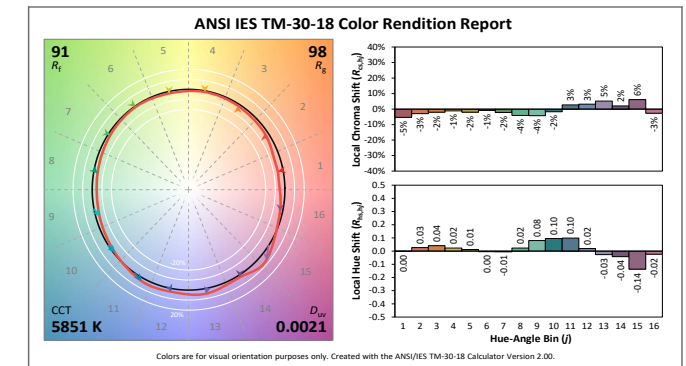

Additional Color Metrics	
CRI $R_a$ ( $R_g$ )	93 (63)
TLCI	94

Product Dimensions

Model	Height		Width		Depth		Weight	
	in	mm	in	mm	in	mm	lb	kg
Halcyon Gold**	26.4	670	16.7	424	11.6	294	62.0	28.1
Halcyon Gold in Box with Molded Insert	23.0	584	22.0	536	28.0	559	94.0	42.6

\*\*Does not include mounting hardware

Halcyon Gold

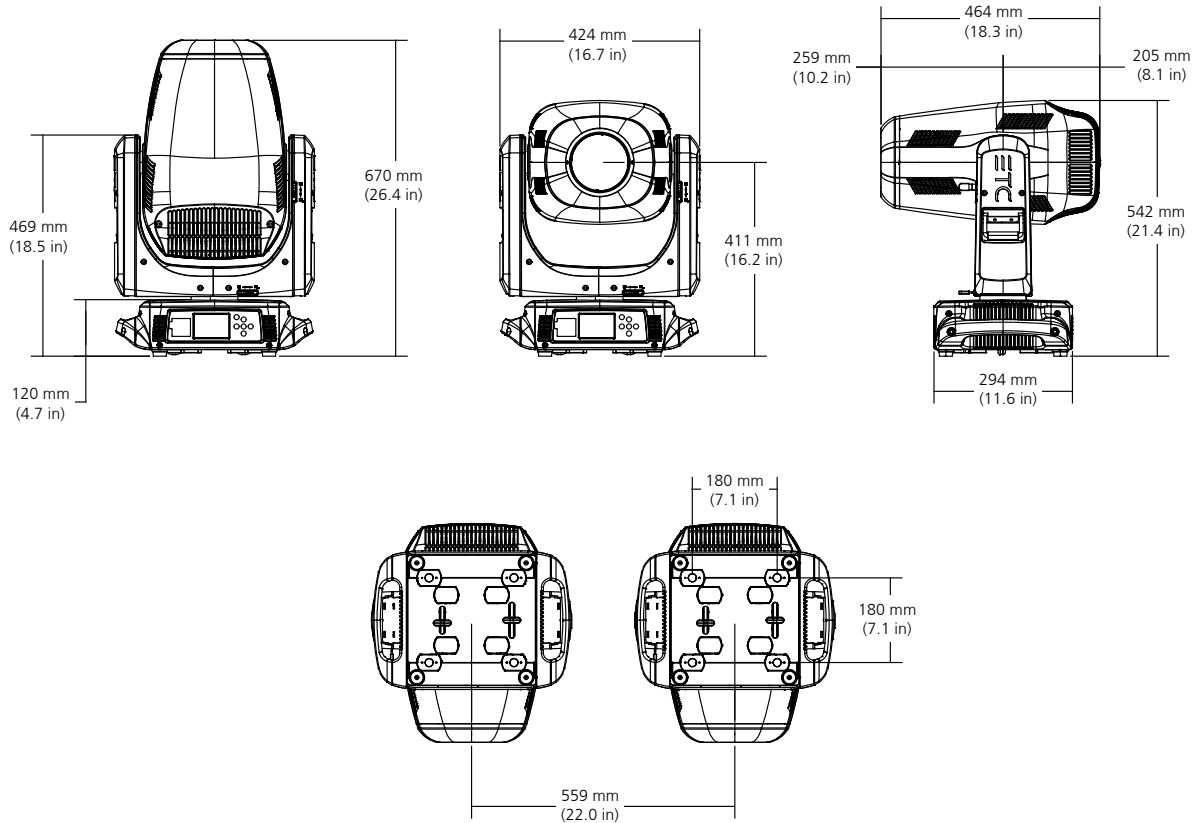

Power Table

VAC	Amps	Hz	Watts	VA	PF
100	6.9	50	684	691	0.99
120	5.7	60	674	676	0.98
200	3.4	50	649	676	0.95
208	3.3	60	646	608	0.94
220	3.1	50	646	674	0.95
230	3.0	50	646	676	0.94
240	2.9	60	644	697	0.91

ADDITIONAL ORDERING INFORMATION

Additional Accessories

Model Number	Description
H7150008	Extra Omega brackets

Molded Case Insert Dimensions

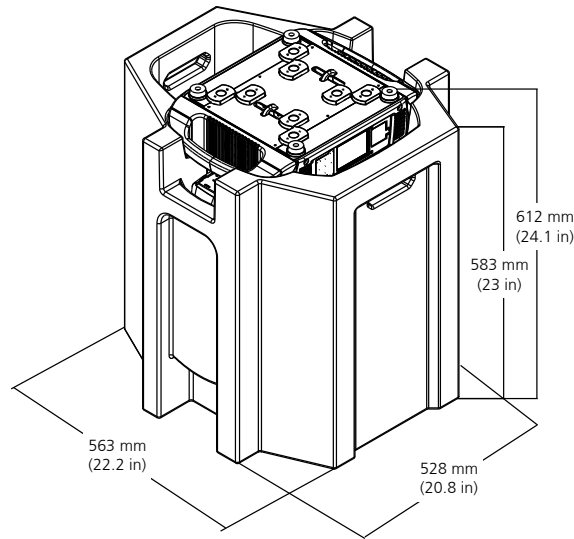

Optional Roadcase Dimensions

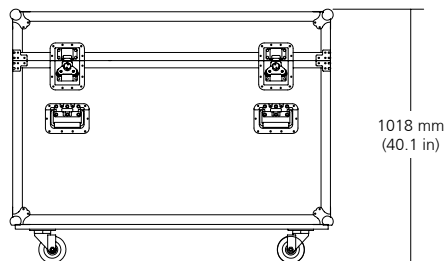
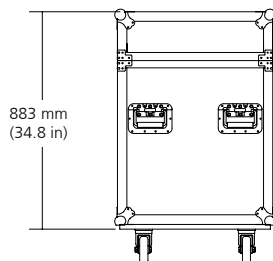
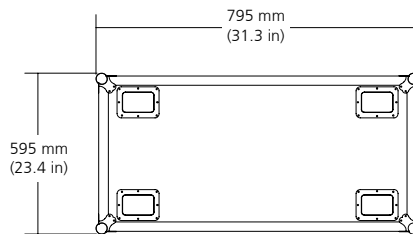

Corporate Headquarters • Middleton, WI USA

Global Offices • London, UK • Rome, IT • Holzkirchen, DE • Paris, FR • Hong Kong  
Dubai, UAE • Singapore • New York, NY • Orlando, FL • Los Angeles, CA • Austin, TX

©2023 ETC. All Rights Reserved. All product information and specifications subject to change. Rev C 2023-08

\*Trademark and patent info: [etconnect.com/IP](http://etconnect.com/IP) • Third-party license agreement info: [etconnect.com/licenses](http://etconnect.com/licenses)

