



Type(s)
Project
Date
Notes

OVERVIEW

Fixture Overview

SolaFrame Studio is a fanless, convection-cooled automated luminaire that prioritizes high quality features, spectral output and silence. When you need an automated lighting product that is audibly invisible and visually impactful, the SolaFrame Studio is the right choice. With a feature set designed for exquisite projection control and beautiful color rendering, SolaFrame Studio can quietly steal the scene.

Applications

- Theatres of all sizes
- Concert halls
- Opera houses
- Film and television broadcast studios
- Churches and houses of worship

Product Features

- Bright white LED engine
- 300 W High CRI engine producing 10,000 field lumens
- Color-matched convection-cooled engine for completely fanless operation.
- High quality 13-lens optic system with patented Lens Defogger
- Extremely powerful 5.5°–57° zoom
- CMY/CTO-Linear color mixing system
- Seven position plus open replaceable Color Wheel
- Full-curtain framing system for total control of beam shaping
- 16-blade iris for extremely tight beam effects
- Light diffusion with additional, optional heavy diffusion
- Seven position plus open Rotating Gobo Wheel
- Linear rotating prism for controlled pattern replication across a stage

ORDERING INFORMATION

SolaFrame Studio

Model	Description
2560A1211	SolaFrame Studio, High CRI, black with styrofoam packaging

Color Options: Fixtures ship standard in black. White available by request.
Included Accessories: Fixture includes two (2) Omega brackets, one (1) fixture power cord, bare ends to powerCON® TRUE1® input, and a safety cable.

Accessories

Model	Description
2560A2083	Optional Heavy Frost for Prism arm mounting
2560B7009	Fixture Power Cord upgrade, 5-15 Edison to powerCON TRUE1, 15 A
2560B7005	Fixture Power Cord upgrade, Stage Pin to powerCON TRUE1, 20 A
2560B7006	Fixture Power Cord upgrade, L6-20 to powerCON TRUE1, 20 A
2560B7007	Fixture Power Cord upgrade, L5-20 to powerCON TRUE1, 20 A
67040007	MegaClaw™
55040014	Cheeseborough 2" Alloy 1/2 Coupler Truss Clamp
67040010	Mini-Claw™



PRODUCT SPECIFICATIONS

Source

Engine	Bright White High CRI
LED Details	300 W
Max Field Lumens	9,900 lumens
Integrating Sphere Lumens	10,100 lumens
LPW	32.9
LED Life	50,000 hours
Native CCT	5700 K
Transferable Light Engine	Yes

Color

Color Mixing	Cyan, magenta, yellow, CTO-linear
Color Temperature	Variable down to 2800 K
Color Wheel	Seven (7) interchangeable dichroic chips plus open

Optical

Beam Angle Range	5.5°–57°
Gate Size	22 mm (7/8 in)
Aperture Size	127 mm (5.0 in)
Pattern Projection	Rotating and indexable wheel with seven (7) patterns plus open
Animation	Bi-directional animation wheel LED animation
Prism	Four facet linear rotating prism
Frost	Light frost and heavy frost optional in place of prism
Iris	16-blade iris
Framing	Four-plane, full-curtain framing system with 90° module rotation
Flicker Control/Hz Range	2.4 kHz or 16 kHz

Control

Input Method	DMX (5-pin) or Ethernet
Protocols	DMX via RS-485 Art-Net or sACN via Ethernet
Ethernet Pass-Thru	Passive Ethernet in and thru with and without power
Data Conversion	Patented data conversion system for: DMX to Ethernet Ethernet to DMX
Modes (Footprint)	Standard or Dual Frost (48 channels)
RDM Functions	Yes
UI Type	Full color graphical UI with 6-button navigational control
Local Control	Yes
Dimming Performance	16-bit, DMX controlled

Electrical

Voltage Range	100–240 V, 50–60 Hz
Input Method	powerCON TRUE1
Wattage (Standard/+Defogger)	629 W / 667 W
Current (Max)	6.3 A @ 100 V

Thermal

Ambient Operating Temp	-10°–35°C (14°–95°F)
Fan Mode	Fanless, Convection-cooled
Stationary Noise	23 dBA at full intensity (16.3 dBA background noise)

Physical

Pan and Tilt Range	540° pan, 263° tilt
Max Pan/Tilt Speed	360° in 2.7 s / 180° in 1.5 s
Materials	Steel and aluminum frame with molded plastic covers
Color Options	Black, white by request
Mounting Options	Any orientation
IP Rating	IP20
Weight	34 kg (75 lb)
Included Accessories	powerCON TRUE1 to bare end fixture tail Two (2) clamp brackets Safety cable

Warranty

Fixture Warranty	Five (5) year for light engine Two (2) year for complete fixture
Warranty Details	highend.com/warranty

Regulatory & Compliance

Regulatory Standards	Listed to UL 1573 Certified to CSA STD. C22.2 No: 166 EAC
CE compliance declared to these standards	Safety: EN 60598-1, EN 60598-2-17, EN 62031, EN 62471 EMC: EN 55015, EN 61547, EN 61000-3-2, EN 6100-3-3
Complies to the ROHS directive	Yes

Safety

Safety	Minimum distance to illuminated surface = 2.0 m (6.5 ft) Minimum distance from fixture head to combustible materials = 0.1 m (0.33 ft)
--------	---

Notes: All LED sources experience some lessening of light output and some color shift over time. LED output will vary with thermal conditions. Thermal conditions can be affected by ambient temperatures and orientation.

FEATURE DETAILS

Rotating Gobo Details







Outside Diameter	25 mm (0.98 in)
Image Diameter	20 mm (0.78 in)
Materials	0.5 mm aluminum 1.1 mm glass Borofloat®

Color Wheel Details

Shape	Interchangeable wedge
Materials	1.1 mm glass Borofloat

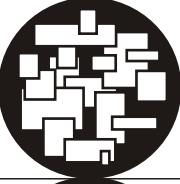
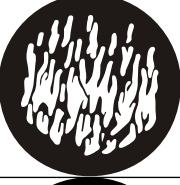
Animation Wheel Details

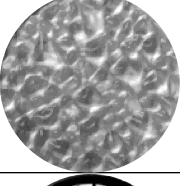
Movement	Bi-directional continuous rotation
Materials	0.6 mm aluminum

	1 - Fracture
	2 - Polymoba
	3 - Modern
	4 - Fire
	5 - Crescents
	6 - Ice
	7 - Foliage (Glass)

	1 - Red
	2 - Blue
	3 - Green
	4 - Yellow
	5 - Orange
	6 -Purple
	7- Dark Blue

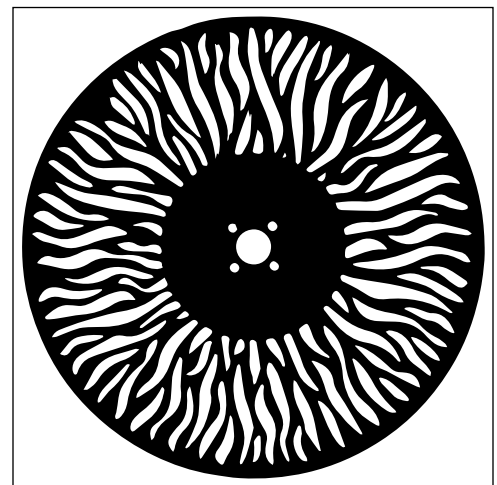

PHOTOMETRIC DATA

SolaFrame Studio - High CRI

	Degree	Candela	Field Lumens	Power Usage	Lumens Per Watt
Narrow	5.5°	752,800	5,584	300 W	19
Medium	26°	77,700	9,051	300 W	31
Wide	57°	18,200	9,895	300 W	33

Narrow - 5.5°

Throw Distance	10 ft 3.0 m	20 ft 6.1 m	30 ft 9.1 m	50 ft 15.2 m	200 ft 61 m
Field Diameter	1.0 ft 0.3 m	1.9 ft 0.59 m	2.9 ft 0.88 m	4.8 ft 1.47 m	19.2 ft 5.86 m
Illuminance (fc)	7,528	1,882	837	302	19
Illuminance (lux)	81,000	20,250	9,000	3,240	203

Medium - 26°

Throw Distance	10 ft 3.0 m	20 ft 6.1 m	30 ft 9.1 m	50 ft 15.2 m	200 ft 61 m
Field Diameter	4.6 ft 1.41 m	9.2 ft 2.82 m	13.9 ft 4.23 m	23.1 ft 7.04 m	92.3 ft 28.15 m
Illuminance (fc)	777	195	87	32	2
Illuminance (lux)	8,360	2,090	929	334	21

Wide - 57°

Throw Distance	10 ft 3.0 m	20 ft 6.1 m	30 ft 9.1 m	50 ft 15.2 m	200 ft 61 m
Field Diameter	10.9 ft 3.31 m	21.7 ft 6.62 m	32.6 ft 9.93 m	54.3 ft 16.55 m	217.2 ft 66.20 m
Illuminance (fc)	182	46	21	8	1
Illuminance (lux)	1,958	490	218	78	5

To determine center beam illumination in footcandles at any throw distance, divide candela by the throw distance squared.

Metric conversions: For meters, multiply feet by 0.3048.
For lux, multiply footcandles by 10.76.

SolaFrame Studio - Spectral Data

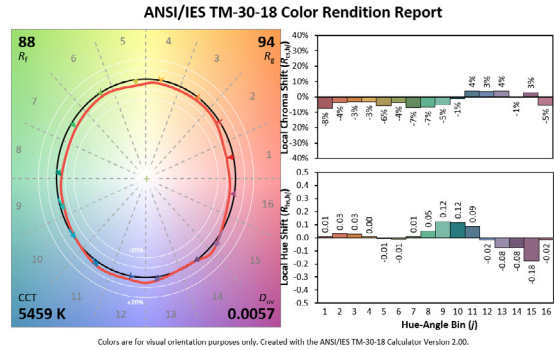

Additional Color Metrics	
CRI R_a (R_g)	90 (47)
TLCI	89

PHYSICAL INFORMATION

SolaFrame Studio Dimensions

Model	Height		Width		Depth		Weight	
	in	mm	in	mm	in	mm	lb	kg
SolaFrame Studio*	29.3	744	18.6	473	12.9	327	75	34
SolaFrame Studio with foam packaging	33	838	24	610	18	457	90	41

*Does not include mounting hardware

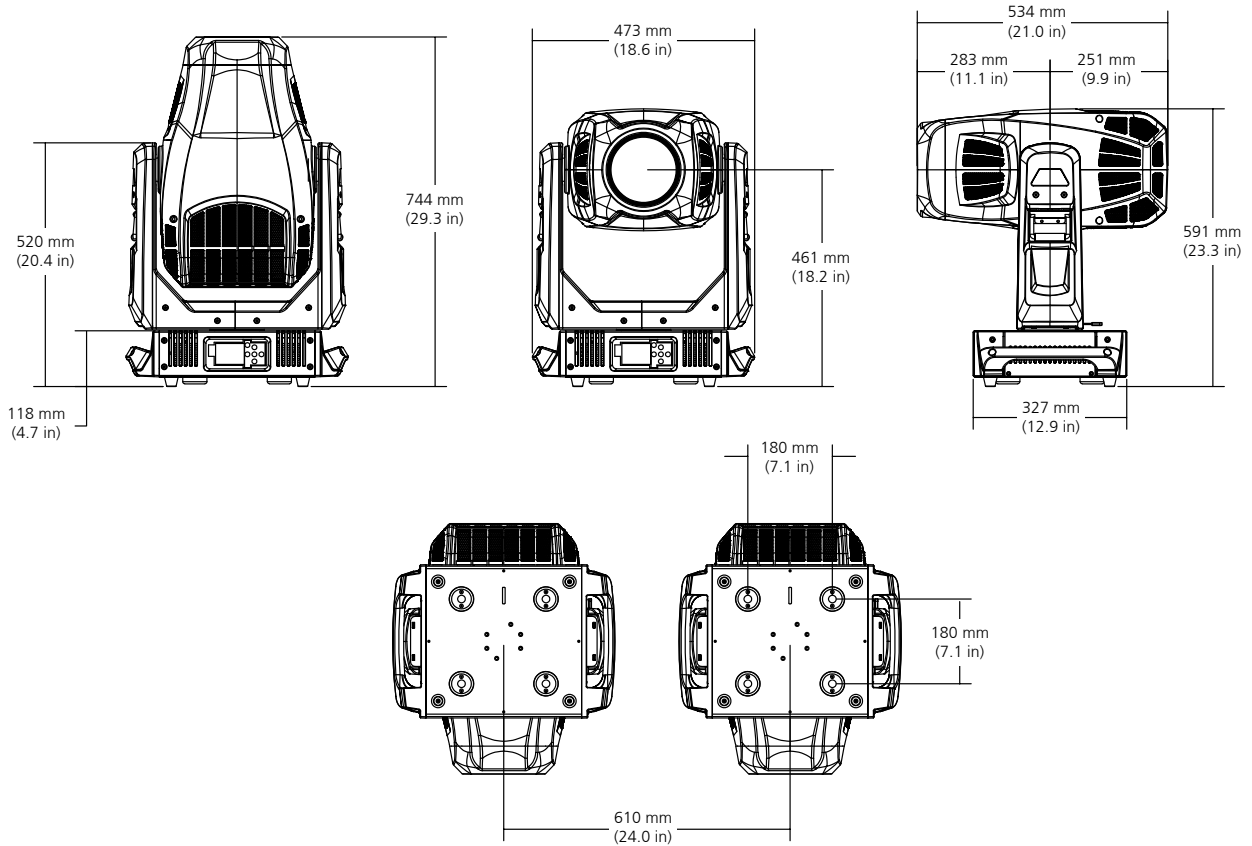

Power Table

VAC	Amps	Hz	Watts	VA	PF
100	6.3	50	629	628	0.99
120	5.2	60	614	619	0.99
200	3.0	50	588	610	0.97
208	2.9	60	587	604	0.97
220	2.8	50	586	613	0.96
230	2.7	50	592	615	0.96
240	2.5	60	585	607	0.96



Corporate Headquarters • Middleton, WI USA
 Global Offices • London, UK • Rome, IT • Holzkirchen, DE • Paris, FR • Hong Kong
 Dubai, UAE • Singapore • New York, NY • Orlando, FL • Los Angeles, CA • Austin, TX
 Copyright©2022 ETC. All Rights Reserved. All product information and specifications subject to change. Rev D 2022-10
 *Trademark and patent info: etcconnect.com/IP