



Type(s)
Project
Date
Notes

OVERVIEW

Fixture Overview

When you need an automated lighting product that cuts through the haze, a fixture with the power to shine in the world's largest venues, you need the SolaHyBeam 3000. Powered by an exceptionally efficient White Light LED engine, the large front aperture and optimized long-throw optics give you even more light as you approach the fixture's wonderful narrow zoom. Add in a feature set designed for beam control and aerial effects, and what you get is a fixture that can throw light from the back of the house, to the front, and all the way back again. All while lighting the haze aflame with color and light.

Applications

- Arenas and stadiums
- Large theatres
- Film and television broadcast studios
- Large scale events
- Megachurches and houses of worship

Product Features

- Bright white LED engine
- 750 W Ultra-Bright engine producing 37,000 field lumens or High Fidelity Engine with incredibly accurate color rendering
- Massive 210 mm glass front lens with patented Lens Defogger
- Extremely powerful 4.5°–50° zoom
- CMY/CTO - Linear color mixing system
- Six position plus open replaceable Color Wheel
- Framing system for total control of beam shaping
- 16-blade iris for extremely tight beam effects
- Beautifully linear Trifusion frost system
- Seven position plus open Rotating Gobo Wheel
- Three Prisms on two planes, unleashing dual-prism effects
- TM-30 Filter boosts the Ultra-Bright Engine color rendering

ORDERING INFORMATION

SolaHyBeam 3000

Model	Description
2581A1400-B	SolaHyBeam 3000, Ultra-Bright, black with molded insert
2581A1401-B	SolaHyBeam 3000, High Fidelity, black with molded insert
2581K1001	Roadcase for SolaHyBeam 3000

Color Options: Fixtures ship standard in black. White available by request.
Included Accessories: Fixture includes two (2) Omega Brackets, one (1) fixture power cord, bare ends to powerCON® TRUE1® input, and a safety cable.

Accessories

Model	Description
2560B7004	Fixture Power Cord upgrade, 5-20 Edison to powerCON TRUE1, 20 A
2560B7005	Fixture Power Cord upgrade, Stage Pin to powerCON TRUE1, 20 A
2560B7006	Fixture Power Cord upgrade, L6-20 to powerCON TRUE1, 20 A
2560B7007	Fixture Power Cord upgrade, L5-20 to powerCON TRUE1, 20 A
67040007	MegaClaw™
55040014	Cheeseborough 2" Alloy 1/2 Coupler Truss Clamp
67040010	Mini-Claw™



PRODUCT SPECIFICATIONS

Source

Engine Options	Ultra-Bright	High Fidelity
LED Details	750 W	750 W
Max Field Lumens	37,000 lumens	23,500 lumens
Integrating Sphere Lumens	40,000 lumens	25,000 lumens
LPW	47	29
LED Life	50,000 hours	50,000 hours
Native CCT	6700 K	5700 K
Transferable Light Engine	Yes	Yes

Color

Color Mixing	Cyan, magenta, yellow, CTO-linear
Color Temperature	Variable down to 2800 K
Color Wheel	Six (6) interchangeable dichroic chips plus open including TM-30 filter standard

Optical

Beam Angle Range	4.5–50°
Gate Size	30 mm (1.2 in)
Aperture Size	210 mm (8.27 in)
Pattern Projection	Rotating and indexable wheel with seven (7) patterns plus open
Animation	LED Animation
Prism	Three prisms on two planes for simultaneous prisms
Frost	Trifusion for smooth and even linear frost with bright edgeless design
Iris	16-blade iris
Framing	Four-plane, full-curtain framing system with 90° module rotation
Flicker Control/Hz Range	100 Hz, 2.4 kHz, or 16 kHz

Control

Input Method	DMX (5-pin) or Ethernet
Protocols	DMX via RS-485 Art-Net or sACN via Ethernet
Ethernet Pass-Thru	Passive Ethernet in and thru with and without power
Data Conversion	Patented data conversion system for: DMX to Ethernet Ethernet to DMX
Modes (Footprint)	One (53)
RDM Functions	Yes
UI Type	Full color graphical UI with 6-button navigational control
Local Control	Yes
Dimming Performance	16-bit, DMX controlled

Electrical

Voltage Range	100-240 VAC, 50-60 Hz
Input Method	powerCON TRUE1
Wattage (Max)	1,276 W
Current (Max)	12.8 A @ 100 V

Thermal

Ambient Operating Temp	-10°–45°C (14°–113°F)
Fan Mode	Standard, Studio, Continuous, Studio Continuous
Stationary Noise	Standard - 35.6 dBA Studio - 28.4 dBA Continuous - 40.4 dBA Studio Continuous - 35.8 dBA
Lens Defogging	Patented Lens Defogger included

Physical

Pan and Tilt Range	540° pan, 253° tilt
Max Pan/Tilt Speed	360° in 3.1 s / 180° in 2.02 s
Materials	Steel and aluminum frame with molded plastic covers
Color Options	Black, white by request
Mounting Options	Any orientation
IP Rating	IP20
Weight	50.8 kg (112 lbs)
Included Accessories	powerCON TRUE1 to bare end fixture tail Two (2) clamp brackets Safety cable

Warranty

Fixture Warranty	Two (2) year for complete fixture Five (5) year for light engine
Warranty Details	highend.com/warranty/

Regulatory & Compliance

Regulatory Standards	Listed to UL 1573 Certified to CSA STD. C22.2 No: 166 EAC
CE compliance declared to these standards	Safety: EN 60598-1, EN 60598-2-17, EN 62031, EN 62471 EMC: EN 55015, EN 61547, EN 61000-3-2, EN 6100-3-3
Complies to the ROHS directive	Yes

Safety

Safety	Minimum distance to illuminated surface = 2.0 m (6.5 ft) Minimum distance from fixture head to combustible materials = 0.1 m (0.33 ft)
--------	---

Note: All LED sources experience some lessening of light output and some color shift over time. LED output will vary with thermal conditions. Thermal conditions can be affected by ambient temperatures and orientation.



FEATURE DETAILS

Rotating Gobo Details

Outside Diameter	30 mm (1.18 in)
Image Diameter	25 mm (0.98 in)
Materials	0.5 mm aluminum 1.1 mm glass Borofloat®

Color Wheel Detail

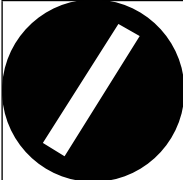
Shape	Interchangeable wedge
Materials	1.1 mm Glass Borofloat

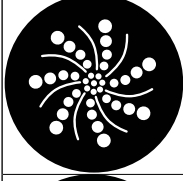
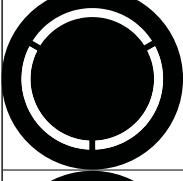
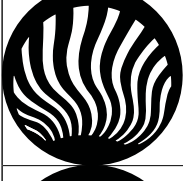
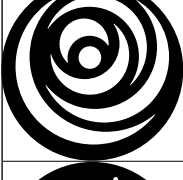
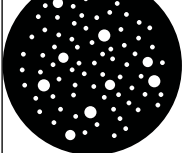
	1 - Bar
	2 - Starvolver
	3 - Pinwheel Dots
	4 - Tunnel
	5 - Seashell
	6 - Crescents
	7 - Shower

	1 - Red
	2 - Blue
	3 - Green
	4 - TM-30
	5 - Orange
	6 -Dark Blue

PHOTOMETRIC DATA

SolaHyBeam 3000 - Ultra-Bright

	Degree	Candela	Field Lumens	Power Usage	Lumens Per Watt
Narrow Beam	4.5°	3,063,300	31,975	750 W	38
Narrow Wash	10°	1,507,000	29,054	750 W	43
Medium Wash	26°	278,200	32,426	750 W	39
Wide Wash	50°	77,600	35,563	750 W	42

Narrow Beam - 4.5°

Throw Distance	10 ft 3.0 m	20 ft 6.1 m	30 ft 9.1 m	50 ft 15.2 m	200 ft 61 m
Field Diameter	0.8 ft 0.2 m	1.6 ft 0.5 m	2.4 ft 0.7 m	3.9 ft 1.2 m	15.7 ft 4.8 m
Illuminance (fc)	30,633	7,659	3,404	1,226	77
Illuminance (lux)	329,610	82,403	36,623	13,184	824

Narrow Wash - 10°

Throw Distance	10 ft 3.0 m	20 ft 6.1 m	30 ft 9.1 m	50 ft 15.2 m	200 ft 61 m
Field Diameter	1.7 ft 0.54 m	3.5 ft 1.07 m	5.2 ft 1.60 m	8.7 ft 2.67 m	35.0 ft 10.67 m
Illuminance (fc)	15,070	3,768	1,675	603	38
Illuminance (lux)	162,150	40,538	18,017	6,486	405

Medium Wash - 26°

Throw Distance	10 ft 3.0 m	20 ft 6.1 m	30 ft 9.1 m	50 ft 15.2 m	200 ft 61 m
Field Diameter	4.6 ft 1.41 m	9.2 ft 2.82 m	13.9 ft 4.23 m	23.1 ft 7.04 m	92.3 ft 28.15 m
Illuminance (fc)	2,782	696	310	112	7
Illuminance (lux)	29,925	7,481	3,325	1,197	75

Wide Wash - 50°

Throw Distance	10 ft 3.0 m	20 ft 6.1 m	30 ft 9.1 m	50 ft 15.2 m	200 ft 61 m
Field Diameter	9.3 ft 2.9 m	18.7 ft 5.7 m	28.0 ft 8.5 m	46.6 ft 14.2 m	186.5 ft 56.9 m
Illuminance (fc)	776	194	87	32	2
Illuminance (lux)	8,345	2,086	927	334	21

SolaHyBeam 3000 - High Fidelity

	Degree	Candela	Field Lumens	Power Usage	Lumens Per Watt
Narrow Beam	4.5°	1,991,200	20,784	750 W	28
Narrow Wash	10°	979,600	18,885	750 W	26
Medium Wash	26°	180,800	21,077	750 W	29
Wide Wash	50°	50,500	23,116	750 W	31

Narrow Beam - 4.5°

Throw Distance	10 ft 3.0 m	20 ft 6.1 m	30 ft 9.1 m	50 ft 15.2 m	200 ft 61 m
Field Diameter	0.8 ft 0.2 m	1.6 ft 0.5 m	2.4 ft 0.7 m	3.9 ft 1.2 m	15.7 ft 4.8 m
Illuminance (fc)	19,912	4,978	2,213	797	50
Illuminance (lux)	214,247	53,562	23,805	8,570	536

Narrow Wash - 10°

Throw Distance	10 ft 3.0 m	20 ft 6.1 m	30 ft 9.1 m	50 ft 15.2 m	200 ft 61 m
Field Diameter	1.7 ft 0.54 m	3.5 ft 1.07 m	5.2 ft 1.60 m	8.7 ft 2.67 m	35.0 ft 10.67 m
Illuminance (fc)	9,796	2,449	1,089	392	25
Illuminance (lux)	105,404	26,351	11,712	4,216	264

Medium Wash - 26°

Throw Distance	10 ft 3.0 m	20 ft 6.1 m	30 ft 9.1 m	50 ft 15.2 m	200 ft 61 m
Field Diameter	4.6 ft 1.41 m	9.2 ft 2.82 m	13.9 ft 4.23 m	23.1 ft 7.04 m	92.3 ft 28.15 m
Illuminance (fc)	1,808	452	201	73	5
Illuminance (lux)	19,451	4,863	2,161	778	49

Wide Wash - 50°

Throw Distance	10 ft 3.0 m	20 ft 6.1 m	30 ft 9.1 m	50 ft 15.2 m	200 ft 61 m
Field Diameter	9.3 ft 2.9 m	18.7 ft 5.7 m	28.0 ft 8.5 m	46.6 ft 14.2 m	186.5 ft 56.9 m
Illuminance (fc)	505	127	57	21	2
Illuminance (lux)	5,424	1,356	603	217	14

To determine center beam illumination in footcandles at any throw distance, divide candela by the throw distance squared.

Metric conversions: For meters, multiply feet by 0.3048.
For lux, multiply footcandles by 10.76.

SPECTRAL INFORMATION

Ultra-Bright Engine

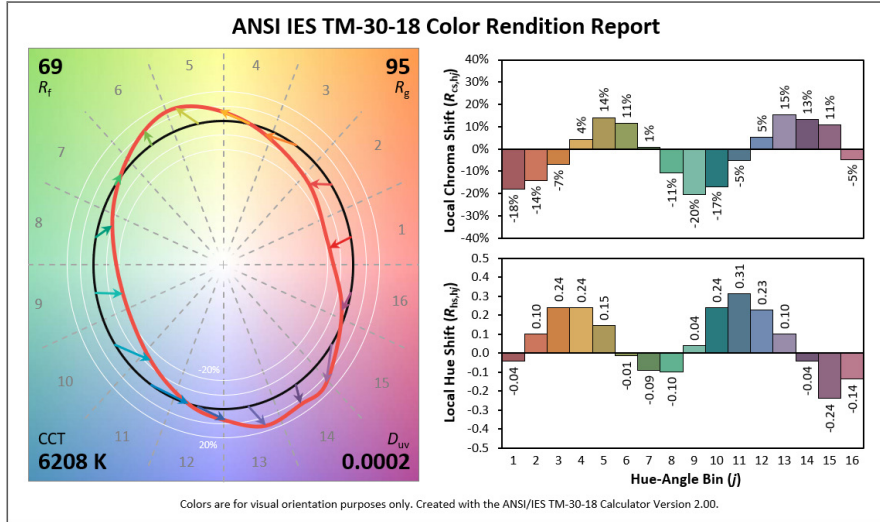

Additional Color Metrics	
CRI R _a (R _g)	69 (-30)
TLCI	44

Ultra-Brite Engine with TM-30 Filter

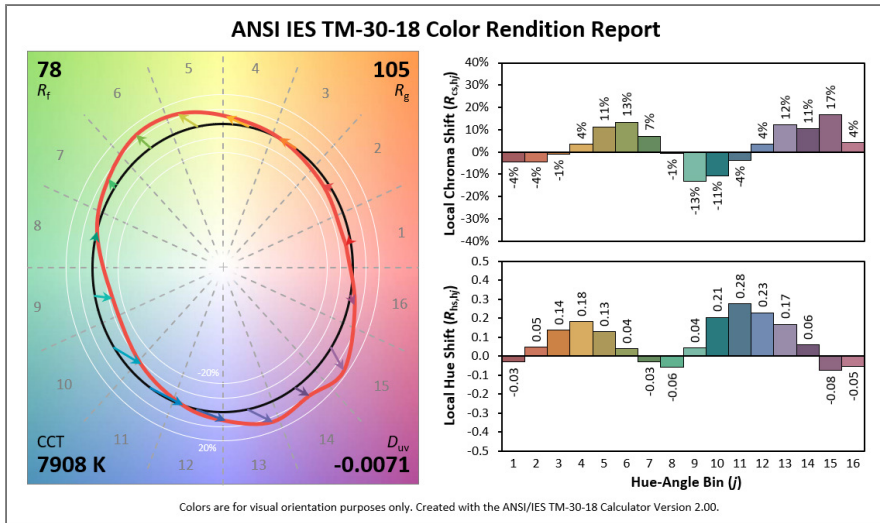

Additional Color Metrics	
CRI R _a (R _g)	82 (69)
TLCI	73

PHYSICAL INFORMATION

SolaHyBeam 3000 Dimensions

Model	Height		Width		Depth		Weight	
	in	mm	in	mm	in	mm	lb	kg
SolaHyBeam 3000*	33.7	856	19.4	494	14.5	368	112	50.8
SolaHyBeam 3000 in Roadcase	40.3	1023	31.3	795	23.4	595		

*Does not include mounting hardware

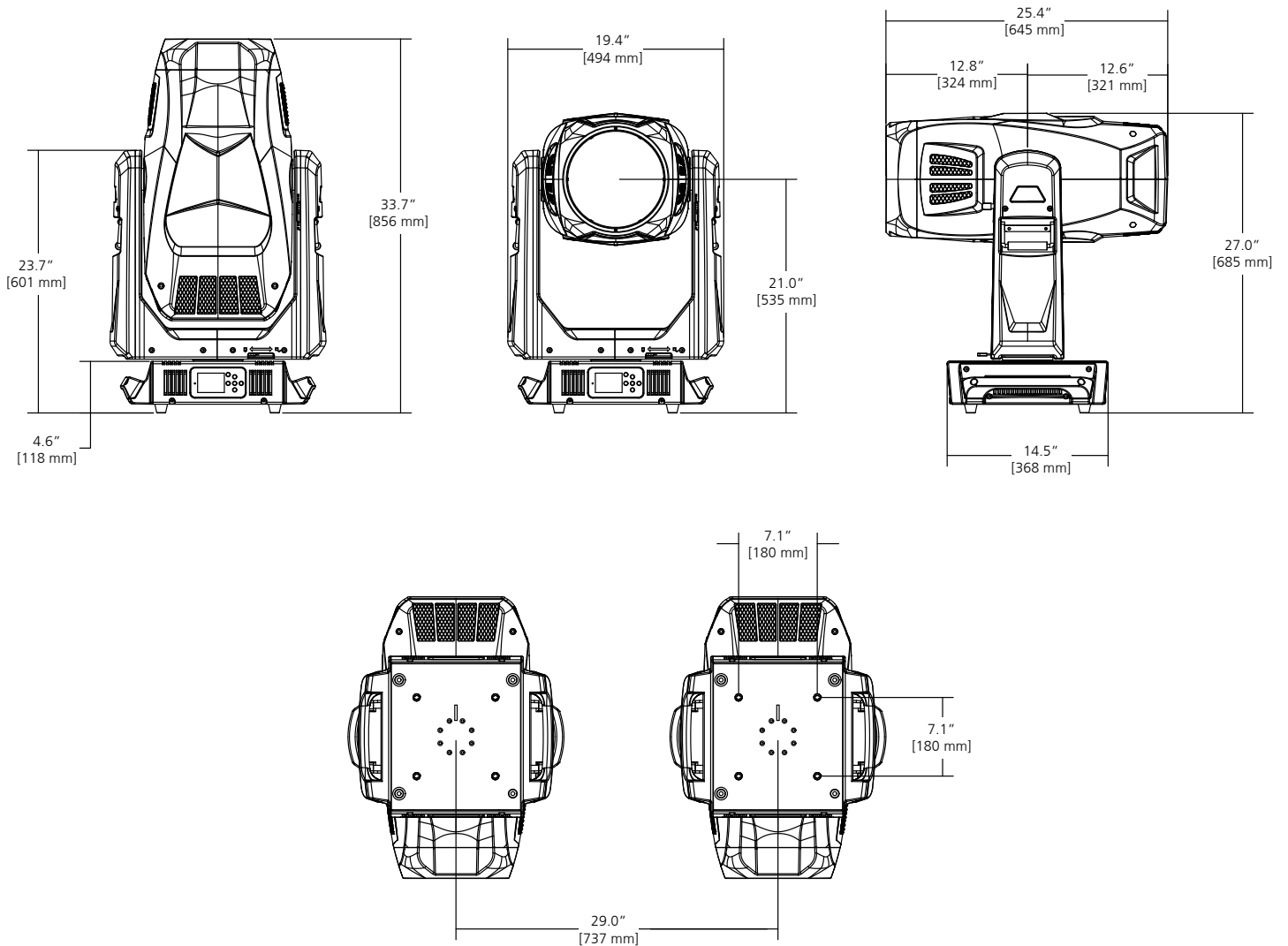

Power Table

VAC	Amps	Hz	Watts	VA	PF
100	12.8	50	1276	1280	0.99
120	10.3	60	1229	1234	0.99
200	5.9	50	1183	1183	0.98
208	5.6	60	1168	1168	0.98
220	5.4	50	1181	1181	0.98
240	4.8	60	1157	1157	0.98

ADDITIONAL ORDERING INFORMATION

Additional Accessories

Model Number	Description
2581A3018	Top Hat (Snoot)
H7500001	Extra Omega brackets
H7300105	Galvanized safety cable with spring snap
2581K1001	Roadcase for SolaHyBeam 3000

Molded Case Insert Dimensions

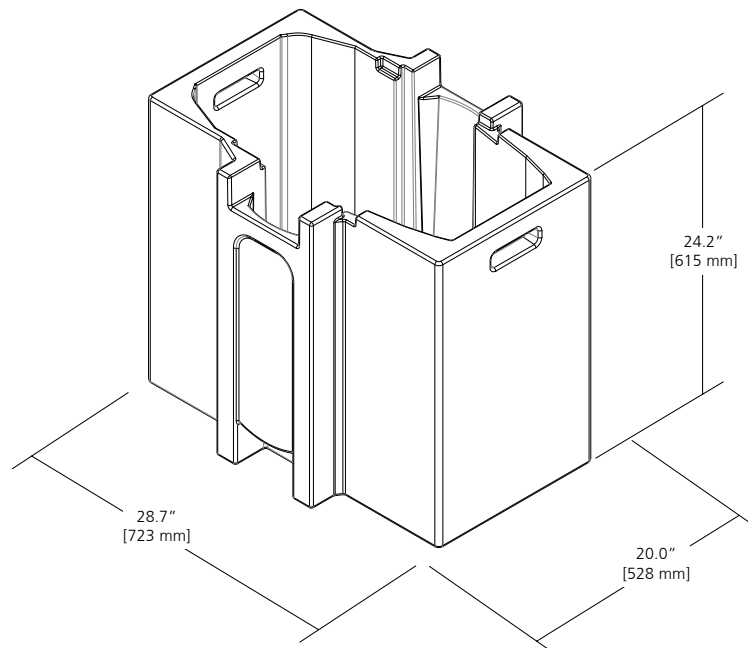

Optional Roadcase Dimensions

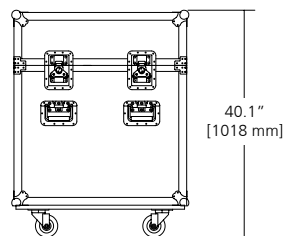
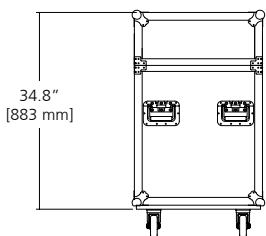
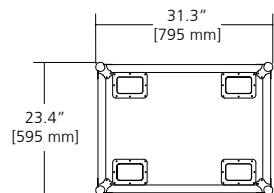

Corporate Headquarters • Middleton, WI USA

Global Offices • London, UK • Rome, IT • Holzkirchen, DE • Paris, FR • Hong Kong
Dubai, UAE • Singapore • New York, NY • Orlando, FL • Los Angeles, CA • Austin, TX

Copyright©2021 ETC. All Rights Reserved. All product information and specifications subject to change. Rev F 2021-08

*Trademark and patent info: etconnect.com/IE

etconnect.com