

ETC Setup Guide

Response MIDI Gateway

Overview

The Response MIDI Gateway supports sending and receiving MIDI (Musical Instrument Digital Interface) control signals. MIDI enables various types of equipment to communicate, control and synchronize with each other through the transmission of digital data. For MIDI output the signal is generated by the controlling device and transmitted to the MIDI Gateway over USB or an Ethernet network to be output locally at the gateway. The gateway itself does not generate MIDI messages.

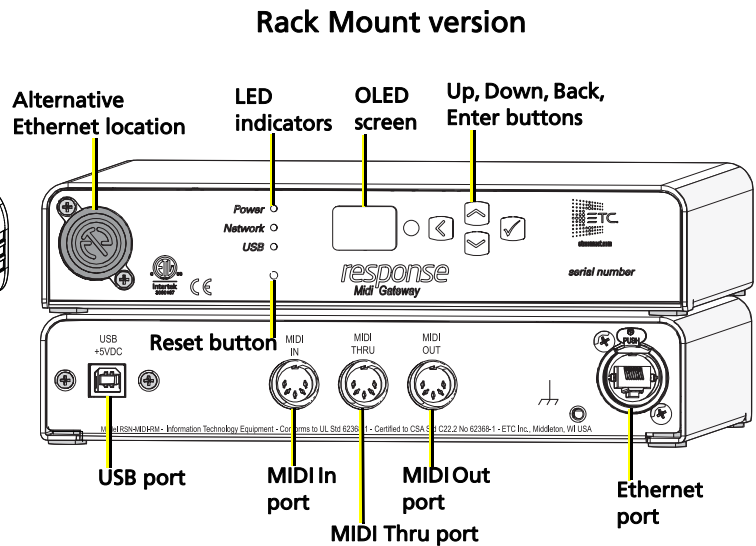
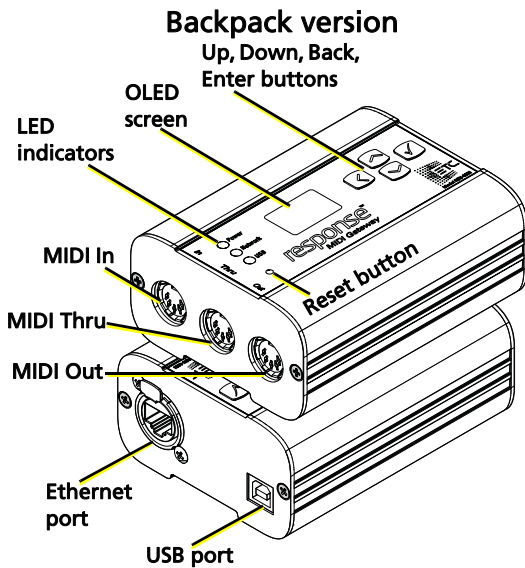

MIDI Connections

The following connections are available:

- MIDI In - allows communication from a MIDI device to a Net3 controller, ACN controller or USB MIDI receiver through the gateway. The input accepts MIDI notes, MIDI Show Control packets and MIDI Time Code
- MIDI Thru - allows communication between multiple MIDI devices by passing the input through the gateway and back out to another MIDI device
- MIDI Out - allows communication with a MIDI device from a Net3, ACN or USB control source through the gateway. Outputs MIDI notes, MIDI Show Control packets and/or MIDI Time Code (MIDI Time Code generated by a third-party device connected via USB)



Note: When connecting to other devices, reference the supporting documentation to ensure protocol compatibility.

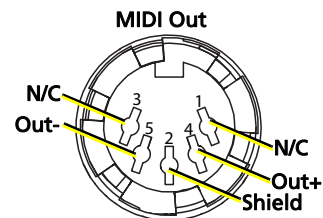
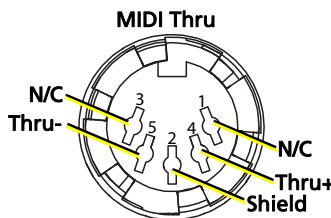
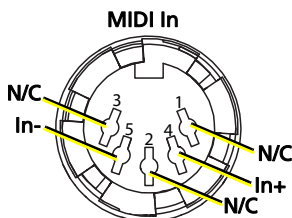

ETC Setup Guide

Response MIDI Gateway Setup Guide

LED Indicators

- Power - solid blue indicates that power is supplied
- Ethernet - solid green indicates network connection and blinking indicates network activity
- USB - solid green indicates USB connection and solid red indicates connection without having fully detected, identified and loaded device drivers

Navigation Buttons

- Up, Down, Back buttons - The Back button allows you to return to the previous menu option and the Up and Down buttons navigate between menu options
- Enter -The Enter button allows you to advance to the next available menu option or commit a modified selection
- Reset - The Reset button provides a physical reset button in case you are not able to reset or reboot from within the software.

Power and Connections

The MIDI Gateway can use Power over Ethernet (PoE) or can be powered by USB. The following connection methods are available:

- Ethernet only: Ethernet is used to supply power (PoE) and to connect to the network
- USB and Ethernet: USB is used only for power and the device is considered a network device
- USB only: When only USB is used, it is powered by USB and can be used as a USB-MIDI converting port.

Switching the Network Port (Rack Mount Only)

The rack mount variant of the MIDI gateway can have the Ethernet connector installed on the front or back of the unit. To switch the location, perform the following steps:

- 1: Using a Phillips screwdriver, remove the four screws on the bottom of the gateway and slide the cover off from front to back.
- 2: Using a Phillips screwdriver, remove the two screws from the nuts securing the blank plate to the gateway.
- 3: Remove the two screws securing the Ethernet connector to the gateway.
- 4: Move the Ethernet connector to the desired location on the gateway and secure with the two screws removed in step 3.
- 5: Secure the blank plate to the other location using the screws and nuts removed in step 2.
- 6: Slide the cover back on the gateway, from back to front and secure with the four screws you removed in step 1.

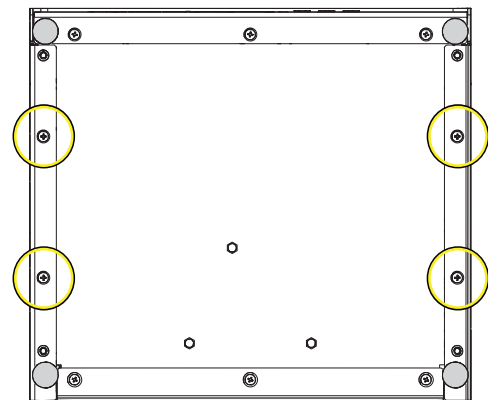

ETC Setup Guide

Response MIDI Gateway Setup Guide

Connect to USB MIDI from the Eos Host

To connect to your MIDI Gateway from the Eos Host, you must enable USB MIDI. For additional information on using MIDI with an Eos console, refer to the *Eos Family Operations Manual*.

- 1: Connect the USB from your MIDI Gateway to your Eos console.
- 2: On your console, navigate to Setup > System > Show Control > MIDI.
- 3: From the Device Settings section, set USB MIDI to Enabled.

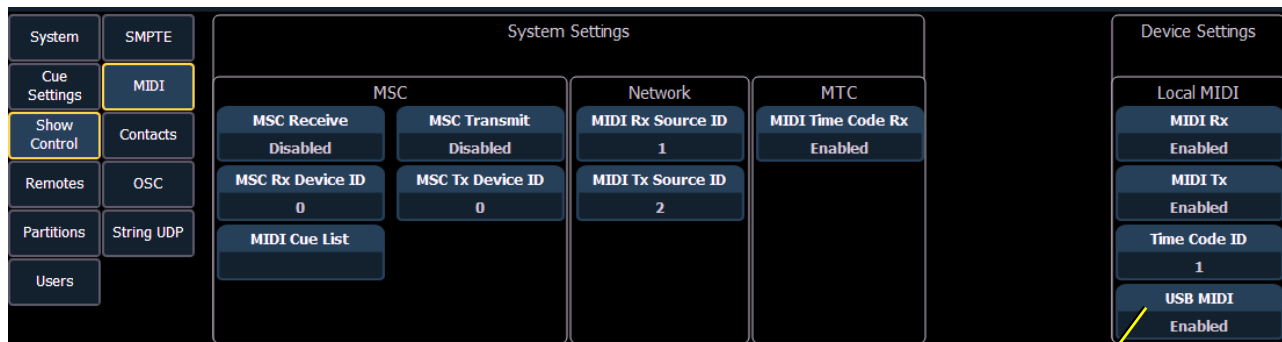

Set to Enabled



Note: You can also enable USB MIDI on your console from ECU > Local I/O.

Connect to your MIDI Gateway Over the Network

- 1: Connect an Ethernet cable to the Ethernet port on you MIDI gateway and then connect the cable to a network switch on your Eos console's lighting network.
- 2: If the port on the switch is not PoE, you can use the USB port to power the gateway.
- 3: On your console, navigate to Setup > System > Show Control > MIDI.

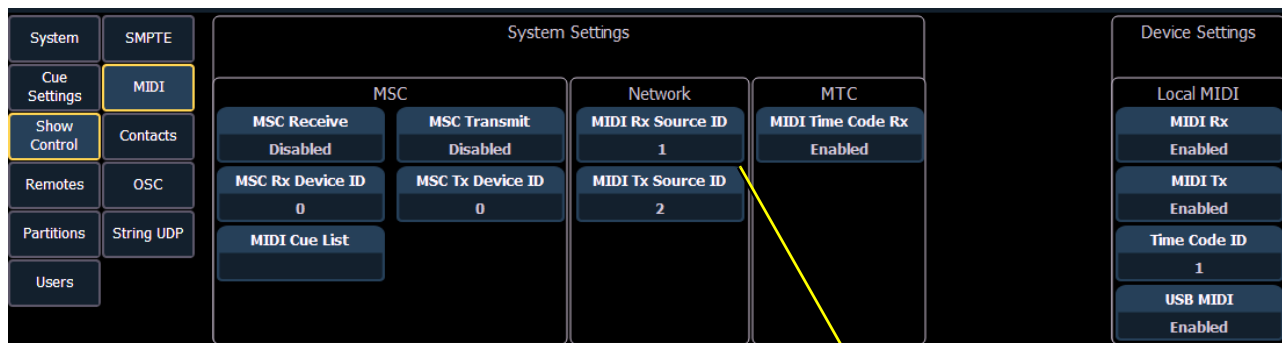

Network MIDI Rx Source ID and MIDI Tx Source ID

- 4: Ensure that the parameter values set for Network MIDI Rx Source ID and MIDI Tx Source ID on your console are also set for the Source IDs for your MIDI gateway:
 - On your MIDI Gateway, press the Check Mark button to bring up the menu
 - Navigate to Setup > Source IDs > (available range is 1-32)

ETC Setup Guide

Response MIDI Gateway Setup Guide

Configuration

You can perform the following tasks using the built-in functionality of the MIDI Gateway. Additional configuration of the MIDI Gateway is done in Net3 Concert. Refer to the MIDI Gateway device-specific Help in Concert for more information.

View Device Information

To view information specific to your gateway, select the About menu from the home screen. From the About menu, you can select one of the following four options:

- Version - Provides the version of software running on the device
- MIDI In - Provides the message type and first and last 5 bytes of the last message received (or a dash if no messages received since last startup)
- MIDI Out - Provides the message type and first and last 5 bytes of the last message sent (or a dash if no messages sent since last startup)

To view the Rx ID and Tx ID associated with your MIDI gateway, select Setup > Source IDs from the home screen.

Configure Network Settings

To configure the network settings for your device, perform the following steps:

- 1: From the home screen, select Setup > Network.
- 2: From the Mode screen, you can use the up and down buttons to select Manual, Link Local or Automatic.
 - Automatic will attempt to automatically configure the IP address, Subnet, and gateway for your device via DHCP.
 - If you select Manual, you must configure the IP Address, IP Subnet, and IP Gateway screens and then select OK from the Apply/Reboot? screen.
 - If you select Link Local, you can have the addressing done using your system's link local addressing mechanism. Select OK from the Apply/Reboot? screen.

If your network settings are not valid after configuration, a warning appears for 3 seconds and then you are returned to the Mode screen and can try again.

Restore Default Settings

To restore the factory defaults for your device, select the Operations menu from the home screen and choose the Restore Defaults option. This removes all network and master/backup information that is configured for your gateway but retains the gateway name.

Update Software

The recommended method of updating the gateway is through UpdaterAtor. The UpdaterAtor application is available for download at etconnect.com.

There is also an option to update the software from the gateway using a TFTP server like Conductor. To upgrade the software, select the Operations menu from the home screen and choose the Update Software option. If you do choose to update directly from the gateway, the bootloader runs and the latest software is downloaded from the server indicated by the <#.#.#> IP address on the Update Software screen. If you need to modify this IP address, you can configure it in the Concert application using the Update Server property.



Note: *Regardless of whether you update from UpdaterAtor or directly from the gateway, the device must be on the network.*

ETC Setup Guide

Response MIDI Gateway Setup Guide

Optional Accessories (Rack Mount Only)

The following accessories are available for use with the rack-mounted Response MIDI Gateway.

Rack Mount Kit

4260K1001: The Gateway Rack Mount kit is capable of holding up to two gateways for mounting into a standard 19" rack enclosure. If you only need to mount one unit, a blanking plate is provided with the kit. This blanking plate can be installed on either side of the rack mount bracket.

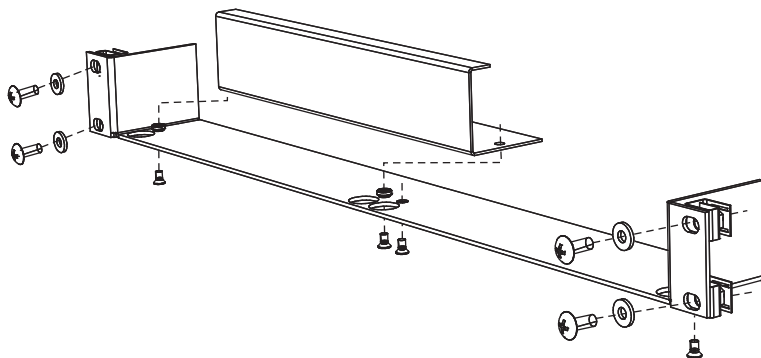

Hanging Hardware Kit

4260K1005: The Hanging Hardware Kit allows pipe mounting of a gateway in a variety of orientations. You can vary the way the U-bolt (or c-clamp) attaches to the bracket and the way the bracket mounts to the gateway. The bracket attaches to any edge on the bottom of your gateway.

