

SX212

Compact Dual-driver Subwoofer

Features

- Compact, direct-radiator subwoofer
- 2 x 12" (300mm) drivers with 3" (75mm) voice coils
- Water resistant cones
- Compact, low-profile styling
- Large ports for reduced air noise
- Perforated steel grille
- Black or white standard colour options
- Integrated flying points

Applications

- Live music clubs and bars
- Nightclubs
- Bars and restaurants
- Museums and AV spaces
- Convention centres
- Hotels
- Retail outlets
- Leisure centres
- Houses of Worship



With twin high-efficiency 12" (300mm)/3" (75mm) voice coil long-throw bass drivers and optimally-sized reflex ports to minimise air noise, the SX212 is the perfect sub-bass where low frequency extension and impact is required from a very compact, unobtrusive, low-profile enclosure.

The SX212 is designed to be used with full-range loudspeaker systems and extends the low frequency operating range of the combined system down to 40Hz. The enclosure is constructed from plywood and is internally-braced to reduce energy transmission to the enclosure panels and baffle. Its perforated

steel grille is pre-curved to withstand damage and it can be supplied fitted with optional flying points.

Finished in black (RAL9005) or white (RAL9016) as standard with integrated flying points, the SX212 can be also be supplied in any RAL colour to order.

When used with full-range systems, crossover and EQ functions can either be performed by the DX0.5 or DX4.0 system controllers.

SX212

Compact Dual-driver Subwoofer

Technical Specifications

Acoustical

TYPE	Compact, dual-driver, direct radiating subwoofer
FREQUENCY RESPONSE (1)	48Hz-150Hz ± 3dB, -10dB @ 35Hz
DRIVER	2 x 12" (300mm)/3" (75mm) voice coil, long excursion, ferrite magnet, waterproof cone
RATED POWER (2)	800W AES, 3200W peak
RECOMMENDED AMPLIFIER	iK42 / VIA5002/5004
SENSITIVITY (10)	106dB
MAXIMUM SPL (9)	132dB continuous, 138dB peak (half space)
NOMINAL IMPEDANCE	4 ohms
DISPERSION (-6dB)	Omnidirectional
CROSSOVER	80-120Hz active
ENCLOSURE	100 litres, Plywood
FINISH	Black or white textured paint
PROTECTIVE GRILLE	Black or white perforated steel
CONNECTORS	2 x NL4
PIN CONNECTIONS	Left to right: Input+, Input -, Link -, Link+
FITTINGS	12 x M10 inserts
DIMENSIONS	(W) 872mm x (H) 390mm x (D) 437mm (W) 34.3ins x (H) 15.4ins x (D) 17.2ins
WEIGHT	39kg (86lbs)

Notes

- (1) Measured on-axis in half (2pi) space at 2 metres, then referred to 1 metre.
- (2) AES Standard ANSI S4.26-1984.
- (3) Measured in half (2pi) space at 2 metres with 1 watt input, using band limited pink noise, then referred to 1 metre.
- (4) Measured in half (2pi) space at 2 metres using band limited pink noise, then referred to 1 metre.
- (5) Measured on-axis in open (4pi) space at 2 metres, then referred to 1 metre.
- (6) Measured in open (4pi) space at 2 metres with 1 watt input, using band limited pink noise, then referred to 1 metre.
- (7) Measured in open (4pi) space at 2 metres using band limited pink noise, then referred to 1 metre.
- (8) Measured in open (4pi) space at 2 metres with 2.83V input, using band limited pink noise, then referred to 1 metre.
- (9) Calculated at 1 metre.
- (10) Measured in half (2pi) space at 2 metres with 2.83V input, using band limited pink noise, then referred to 1 metre.

Trade Descriptions Act

Due to Martin Audio's policy of continuing improvement, we reserve the right to alter these specifications without prior notice. Martin Audio is committed to refining state of the art sound reinforcement, combining in-depth product and field applications research with advanced manufacturing techniques. Every Martin Audio product is built to the highest manufacturing standards and rigorously tested to ensure that it meets the performance criteria specified in the design.

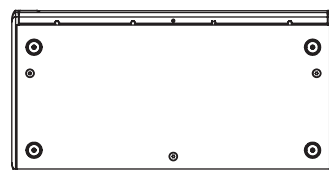
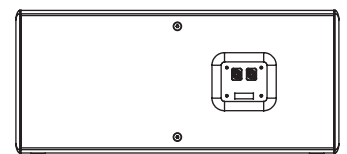
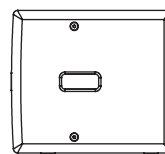
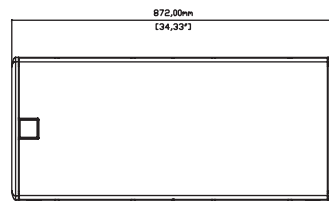
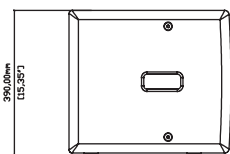
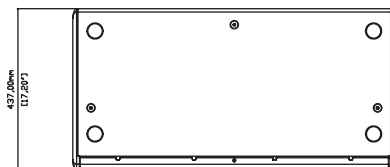
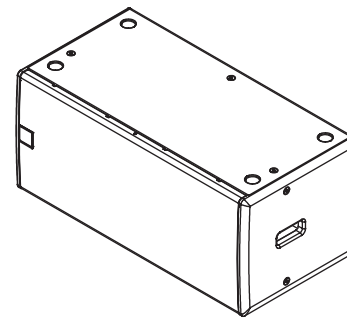

SX212